

ALA-MPX

Automatic analysis and selection of the best MPX modulation source for FM-TX

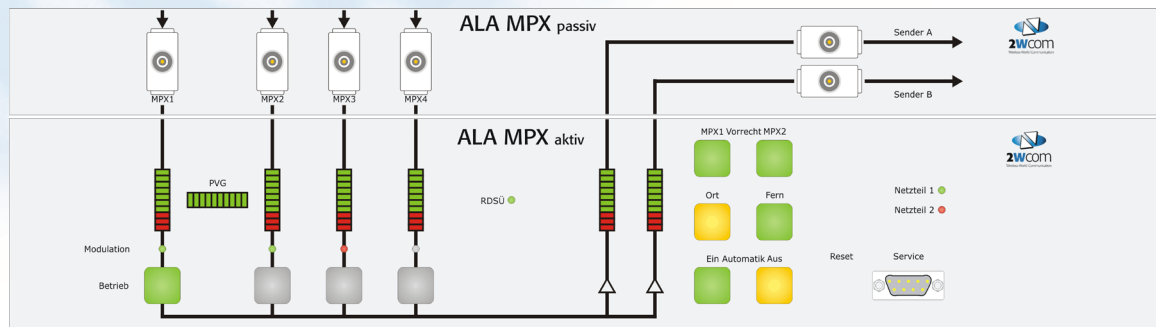

- Level Monitoring of different sources
- Automatic selection of the best modulation source
- Selectable MPX1 / MPX2 priority
- Balanced connection for all inputs and outputs
- Bar graph for quick level control
- Simultaneous RDS monitoring of 3 modulation sources
- MP3 Monitoring based on a TCP/IP data stream
- Two redundant power supplies
- Web-Interface for easy configuration and monitoring
- Fourth modulation input as a backup source while maintenance

The ALA-MPX is switched in front of the FM transmitter and does the automatic selection of the best modulation source to guarantee a safe and high quality transmission.

The task of the ALA-MPX is to supervise the quality of up to 3 modulation signals through level comparison and monitoring and if necessary to initiate an automatic redundancy or manual loss switch.

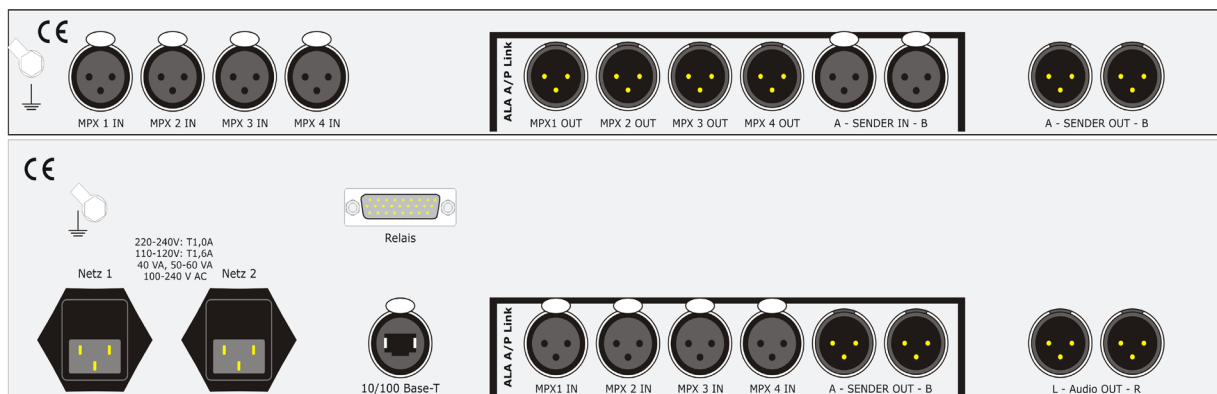

ALA-MPX – Technical Details

ALA-MPX passive unit

Front panel

Bridge connection with measurement options

Plug

Lemo Triax
4x2 for MPX input
2x2 for transmitter output

MPX Input

MPX IN

4x XLR plug, balanced*

TRANSMITTER IN
(connection with active unit)

2x XLR plug, balanced*

MPX Output

MPX OUT

4x XLR socket, balanced*

(connection with active unit)

TRANSMITTER A/B

2x XLR socket, balanced*

* The impedances result from in- and outputs connected to the „ALA-MPX active unit“

ALA-MPX active unit

Front panel

7 bar graph displays
(10 LEDs each)

4x input signal
1x level comparison
2x MPX output

7 Single LEDs

4x input signal (modulation status)
2x power supply A/ B
1x RDS monitoring

Prioritisation switch with control LED

2x Prioritisation MPX1/MPX2
2x on-site/remote
2x automatic on/off

MPX Input

MPX IN

(connection with passive unit)

4x XLR plug,
> 10 k Ω balanced

MPX Output

TRANSMITTER OUT

(connection with passive unit)

2x XLR socket,
< 30 Ω balanced

AUDIO OUT

2x XLR socket,
< 30 Ω balanced

Relais

Outputs

12 relays (10x SPST, 2x SPDT)
(DC/AC: max. 24 V, 1 A, 10W),
26 pol. sub-D male

Ethernet

Socket

RJ45

Type

auto switching
full duplex 10/100 BASE-T

Protocol

HTTP, SNMPv2c, SMTP, UDP

General Data

Service interface

serial, RS232c, front
setting functions

Power consumption

30 VA

Case dimension

1x 19" 1 HU (passive)
2x 19" 2 HU (active)
depth: 310 mm
width: 424 mm
front panel: 484 mm

Weight

active unit: 4,2 kg
passive unit: 2,9 kg

Housing

steel plate (aluminum-zinc coated)

Operating temperature range

0°...45°C

Power supply

Internal, two redundant units,
two line connectors
90 V - 260 V, 47 Hz - 63 Hz

Shipment

1x ALA-MPX active unit
1x ALA-MPX passive unit
2x line cords
1x LAN cable
6x XLR, 25 cm

Version: 04.05.2015
These data are subject to
modifications and amendments.
Errors excepted

